

Parking Standards Supplementary Planning Document (SPD)

September 2011

Contacts for this document

Planning Policy Team
Southampton City Council,
Civic Centre,
Southampton,
SO14 7LS
023 8083 4912
city.plan@southampton.gov.uk



1. Introduction

This document is a Supplementary Planning Document (SPD) partner to Southampton LDF Core Strategy. This SPD provides more detail on specific policies and guidance in the LDF Core Strategy. It sets out approved Parking Standards for Southampton outside the City Centre area as defined by the LDF. The parking standards in this document apply to the whole of the City of Southampton with the exception of the City Centre area, as shown in *Figure 1*.

This Parking Standards SPD is consistent with LDF Core Strategy policy as well as national policy, and gives more up to date guidance than the Local Plan Review¹ in light of revised national policy (PPS3/PPS4, which now give more local flexibility for setting parking standards) for the area outside of the defined City Centre.

This document was published in draft for public consultation between 11 July and 19 August 2011 and has been amended based on the results of this consultation. A summary of consultation is available at the [following web link²](#).

A Sustainability Appraisal and Strategic Environmental Assessment (SEA) relevant to this SPD has been undertaken and can be found at [following weblink³](#). An Equalities Impact Assessment (EqIA) appraisal also carried out and is available at the [following weblink⁴](#).

This document was adopted as Southampton City Council guidance on [date to be inserted](#).

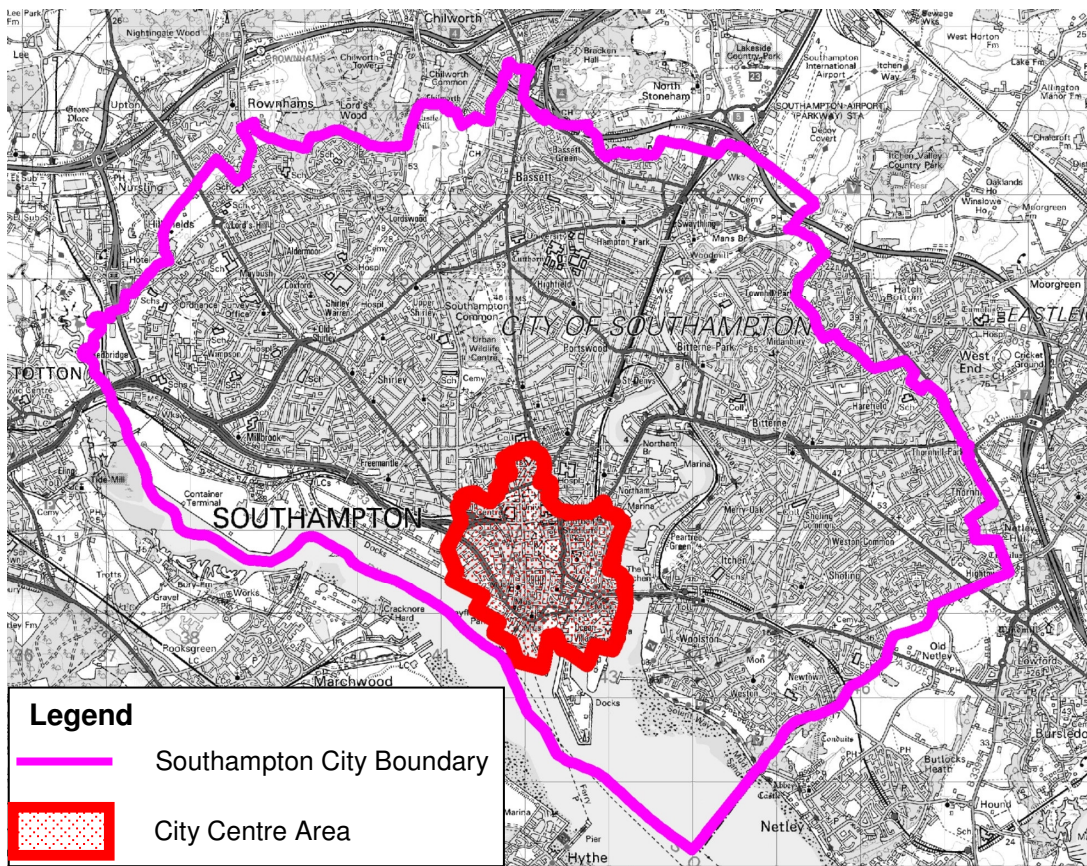

Figure 1: Extents of the area that this Parking Standards SPD applies to

¹ Local Plan Review- Policy SDP5/ Appendices 1-3 inc. Paragraphs 2.30 to 2.42

² Consultation summary doc weblink text to be inserted

³ SEA/Sustainability Appraisal doc weblink text to be inserted

⁴ EqIA doc weblink text in this footnote

1.1 What are the aims of this document?

The basic aim of this document is to ensure that at all new developments, a suitable level of vehicle and cycle parking is provided in order to avoid the various problems that inadequate parking- for vehicles and cycles- can cause.

It also acts to support various other aims of local and national policy. At a national level, this includes working to achieve the requirements of PPG13 and PPS3/4, which advocate taking account of expected car ownership levels, the importance of good design, and the need to use land efficiently. At a local level, it supports the aims of Southampton City Council's LDF and Local Transport Plan 3 (LTP3).

This SPD encourages provision of good quality developments for new and existing residents by setting out clear requirements and guidance to developers regarding what they must and what they should do with regards to parking when designing and seeking approval for residential developments

Finally, in the longer term, this document will help work toward better use and management of the highway network – an SCC statutory duty under the Traffic Management Act (2004).

1.2 Who is this document for?

For developers and their consultants: This document sets out the maximum parking provision for motor vehicles and the minimum parking provision for cycles which must be provided at new developments, in order to gain planning consent. It also sets out SCC's requirements and expectations on the dimensions and general design of aspects of the parking provision at new developments.

For Southampton City Council Members and Officers- This is guidance regarding parking for motor vehicles and cycles which Members and Officers of Southampton City Council will require developers to follow when new developments are proposed.

For members of the public and other stakeholders- Members of the public and other interested parties are encouraged to take a role in the planning process. This document is of use to these groups to see our expectations regarding parking provision at new developments outside the city centre area, and to assist in informing and engaging these groups in the planning process.

1.3 Where does it apply?

The parking standards set out in this document apply to the area within the City of Southampton boundary (shown in *Figure 1*), with the exception of the City Centre area (shown in *Figure 1* as a red shaded area). Parking standards in the City Centre area will be set out in the City Centre Action Plan (CCAP).

1.4 What has been changed?

Completely new residential parking standards have been set out. These are still maximum standards, but maximum values have been considerably increased compared to the previous standards. The structure of the standards has also been considerably simplified compared to the previous standards

New accessibility area definitions are set out. The criteria used to describe an area as “high” accessibility are now stricter than before and the “medium” accessibility zone has been removed, meaning there are only two accessibility level areas defined. This is a simplification compared to the previous standards and is intended to better reflect the reality of non-car accessibility than in the previous Parking Standards.

Inclusion of design guidance. Unlike before, this document sets out minimum dimensions for bay sizes, garages etc to ensure that parking provided at sites is usable for typical vehicles. It also sets out expectations regarding placement of parking bays (for vehicles and cycles) in relation to developments, and provides “good practice” examples from existing sites in Southampton setting out the parking design features we wish to see provided in new developments.

1.5 Who to contact regarding this document

For more information and further copies of this document please contact the Planning Policy team.

Tel: 023 8083 2549/3828

E-mail: city.plan@southampton.gov.uk

Website: <http://www.southampton.gov.uk/s-environment/policy>

Index

1. Introduction	2
1.1 What are the aims of this document?	3
1.2 Who is this document for?	3
1.3 Where does it apply?	3
1.4 What has been changed?	3
1.5 Who to contact regarding this document	4
2. Policy Background	6
2.1 Local Policies	6
2.1.1 Local Development Framework (LDF)	6
2.1.2 Local Transport Plan 3	6
2.1.3 City of Southampton Strategy	7
2.2 National Policies	7
2.2.1 Planning Policy Guidance 13 (PPG13)	7
2.2.2 Planning Policy Statement 3	8
2.2.3 Planning Policy Statement 4 (PPS4)	8
3. Background & Evidence Base	9
3.1 Car Ownership Trends	9
3.2 Future Residential Development	10
3.4. Future Non-residential development	11
3.3 Controlled Parking Zones (CPZs)	12
3.5 Research and experience in Southampton	13
3.6 Justification for the standards set out	13
4. Car Parking Standards	15
4.1 Accessibility areas map	15
4.2 Residential development parking	17
4.2.1 Maximum parking standards	17
4.2.2. Notes on <i>Table 1</i>	17
4.3 Non-residential development parking	20
4.3.1 Additional Notes on <i>Tables 3 to 9</i> - non-residential parking standards	22
4.4 Car Parking for disabled/ less mobile people	24
4.4.1 Notes on <i>Table 9</i> - parking standards for disabled/ less mobile people	24
4.5 Commercial and Passenger Carrying Vehicle Parking Maximum Standards	25
5. Cycle Parking Standards	26
5.1 Cycle parking design guidance	28
5.2 Basic recommendations for Short Stay Cycle Parking	29
5.3 Basic recommendations for Long Stay Cycle Parking	31
6. Powered Two Wheeler Parking	32
7. Transport Assessments	33
8. Travel Plans	34
9. Car parking design guidance	35
10. Bibliography	36

2. Policy Background

2.1 Local Policies

2.1.1 Local Development Framework (LDF)

2.1.1.1 Core Strategy

Southampton's adopted [Local Development Framework \(LDF\) Core Strategy](#)⁵ contains policies relevant to parking. Suitable car and cycle parking provision is recognised by the LDF Core Strategy as one of the key requirements for successful development.

The key policy in the LDF Core Strategy which this Parking Standards SPD supports is Policy CS19- Car and Cycle Parking.

This Parking Standards SPD applies to the area outside of the City Centre zone (as shown in *Figure 1* on page 2). Parking Standards in the City Centre area will be covered in the City Centre Action Plan SPD.

The content of this document also supports and adds detail to content in a number of other policies in the Southampton LDF Core Strategy, namely:

- Policy CS5 – Housing Density;
- Policy CS13- Fundamentals of Design;
- Policy CS16- Housing Mix and Type; and
- Policy CS18- Travel and Transport.

2.1.1.2. LDF Supplementary Planning Documents (SPDs) and Guidance (SPGs)

This Parking Standards SPD document also links to the Southampton City Council [Residential Design Guide SPG](#)⁶ document, and the [Streetscape Manual SPG](#)⁷. Designers and developers should refer to these documents in conjunction with this Parking Standards SPD when considering site access and parking.

2.1.2 Local Transport Plan 3

Southampton's [Local Transport Plan 3](#)⁸ sets out the city's strategy and policies for transport. The LTP3 aims to create a better connected Southampton, in support of the objectives of the City of Southampton Plan. The city's transport strategy is shared with Hampshire County Council and Portsmouth City Council, our partners in Transport for South Hampshire. This Parking Standards SPD is in line with the aims of the long term LTP3 strategy.

2.1.2.1 South Hampshire Joint Strategy

This Parking Standards SPD is in line with and helps deliver the aims and objectives of a number of Policies within the South Hampshire Joint Strategy, including the following:

- Policy C- To optimise the capacity of the highway network and improve journey time reliability for all modes;
- Policy F- To develop strategic sub-regional approaches to management of parking to

⁵ <http://www.southampton.gov.uk/s-environment/policy/developmentframework/core-strategy/stage5.aspx>

⁶ <http://www.southampton.gov.uk/s-environment/policy/planningdocuments/residentialdesignguide.aspx>

⁷ <http://www.southampton.gov.uk/s-environment/policy/planningdocuments/street-scape.aspx>

⁸ <http://www.southampton.gov.uk/s-environment/transportplanning/localtransportplan3/>

support sustainable travel and promote economic development;

- Policy G- To improve road safety across the sub-region;
- Policy H- To promote active travel modes and develop supporting infrastructure;
- Policy L- To work with Local Planning Authorities to integrate planning and transport; and
- Policy M- To develop and deliver high-quality public realm improvements.

2.1.2.2 Southampton LTP3 Implementation Plan

The contents of this Parking Standards SPD supports many of the objectives of the Southampton LTP3 Implementation Plan. In particular, our strategies for areas such as Network Management, Safety, Smarter Choices/Active Travel, and Public Realm are supported.

2.1.3 City of Southampton Strategy

The [City of Southampton Strategy](#)⁹ is the overarching strategy document for the future direction of the city of Southampton. The Strategy provides the framework for tackling the key priorities to realise our 2026 vision of a Southampton which is recognised as the region's economic, social and cultural driving force.

The LDF and its various documents are a key element in delivering our 2026 vision. As detailed in Section 2.1, this Parking Standards SPD supports and builds upon the LDF Core Strategy and partner documents, and hence is a supporting element in working towards achievement of the City of Southampton Strategy's aims.

2.2 National Policies

2.2.1 Planning Policy Guidance 13 (PPG13)

[PPG13](#)¹⁰ sets out the government's policies regarding transport and development planning. The guidance on parking in PPG13 is aimed more at non-residential developments. PPG13 notes that, in the case of trip generators (destinations such as shops, workplaces, leisure facilities) the level of parking provision can strongly influence the mode choice of users accessing these destinations.

The content of this Parking Standards SPD is compliant with all the key points in PPG13. PPG13 has no requirement for Local Authorities to set maximum parking standards for new residential development. It is for local authorities to assess what the most appropriate parking standards should be for any given area, as part of their development and transport strategies. Southampton City Council has decided to continue to use Maximum Parking Standards for residential developments, and have adopted an evidence-led approach to determining appropriate parking standards, as is demonstrated in *Section 3*.

Maximum parking standards are specified in PPG13 for a number of non-residential, non-employment uses above a certain development size threshold. PPG13 allows Local Authorities to adopt more rigorous standards where appropriate but for standard accessibility areas, this

⁹ <http://www.southampton.gov.uk/council-partners/decisionmaking/plans/CoSS.aspx>

¹⁰ <http://www.communities.gov.uk/publications/planningandbuilding/ppg13>

Parking Standards SPD allows provision up to the PPG13-specified maximum parking provision.

2.2.2 Planning Policy Statement 3

[PPS3](#)¹¹ sets out the government's overarching policies on housing. A key instruction in PPS3 is that which requires Local Authorities to, in consultation with stakeholders and communities, *"develop residential parking policies for their areas, taking account of expected levels of car ownership, the importance of promoting good design and the need to use land efficiently"*.

These and other instructions in PPS3 have been taken into account when developing this Parking Standards SPD.

2.2.3 Planning Policy Statement 4 (PPS4)

The guidance in [PPS4](#)¹² (which was published at the end of 2009) sets out the Government's policies for planning for sustainable economic development in urban and rural areas. This guidance has been taken into account when preparing this Parking Standards SPD. Two policies concern car parking provision:

- **Policy EC8-** Car parking for Non Residential Development
- **Policy EC18-** Application of Car parking Standards for Non-Residential Development

These policies essentially instruct local authorities, via their LDFs, to set their own parking standards, appropriate to their area. These parking standards should complement other transport policies (eg the LTP3). Minimum parking standards should not be set other than for parking for disabled people.

¹¹ <http://www.communities.gov.uk/publications/planningandbuilding/pps3housing>

¹² <http://www.communities.gov.uk/publications/planningandbuilding/planningpolicystatement4>

3. Background & Evidence Base

The Parking Standards set out in this document are evidence based. This section provides a summary of the evidence that was considered when setting the parking standards and design guidance contained in Sections 4 to 9.

The requirements of National and Local policy outlined in Section 2 are key influences in the content of this document. We have undertaken research above and beyond the requirements of National and Local Policy, in an attempt to ensure these standards are appropriate for Southampton.

3.1 Car Ownership Trends

There were on average 1.00 cars per household in Southampton in 2010¹³. This value is projected to continue to increase. **Figure 2** shows projected changes in car ownership levels and population against a 2010 index. The total number of cars owned within the city is projected to increase by 26% by 2026, whereas the number of households is projected to increase by only 16%- hence car ownership levels of around 1.15 to 1.20 vehicles per household are predicted. High levels of growth in numbers of households with more than one car is projected (25 to 35% growth by 2026), whilst the number of households with no car is projected to remain fairly steady.

Historical data from 1981, 1991 and 2001 censuses show that these predictions are a continuation of historical patterns, although factors including increased car ownership and fuel costs, planning and economic policies and trends, and the fact that most households already own sufficient cars to meet their needs, are expected to act as controls on levels of car ownership compared to historical data.

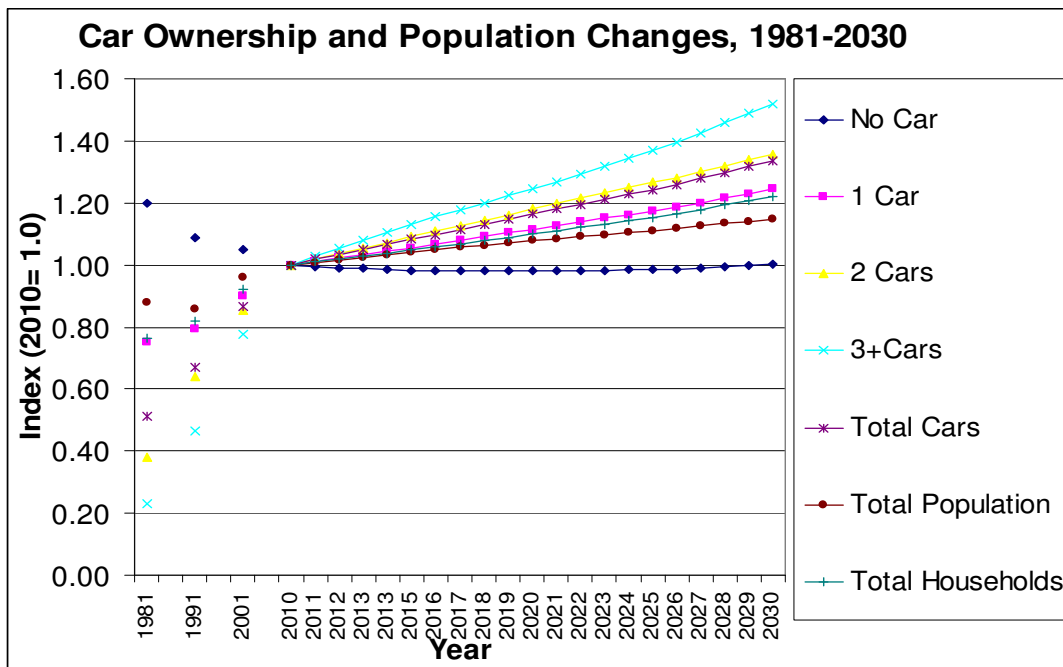

Figure 2: Historical and Future trends in car ownership, population and households in Southampton, 1981 to 2030. Sources 1981,1991,2001 Censuses and TEMPRO 5.4.

Southampton City Council is not prejudiced against car ownership. We recognise that other than for reasons relating to efficient use of land and good housing design, there is no reason to

¹³ TEMPRO v 5.4 (<http://www.dft.gov.uk/tempro/>) and National office for Statistics Census Data for 1981, 1991 and 2001 (<http://www.ons.gov.uk/census/index.html>)

significantly constrain residential parking provision, although it is important to avoid significant over-provision.

However it is imperative that we reduce levels of car use relative to present for economic, health and environmental reasons.

Our primary mechanism of doing so will be by destination-based management of parking (ie parking particularly at workplaces and within the city centre area) coupled with Travel Plans, Smarter Choices and active travel initiatives, and improvements to public transport.

3.2 Future Residential Development

Southampton, through its LDF Core Strategy, is seeking to deliver some 16,300 new residential units between 2006 and 2026. Around 3,000 units of this total have been delivered between 2006 and 2011.

The City Centre Action Plan SPD will address parking standards for future city centre residential development planning applications. This Parking Standards SPD will apply to all development planning applications coming forward outside the city centre area, excluding those planning applications already received.

Southampton City Council estimate that this Parking Standards SPD will apply to planning applications for around 5,500 residential units in the years to 2026, of which 4,200 are anticipated at designated residential development sites, and 1,300 are expected to be at “windfall” applications at sites which have not yet been identified.

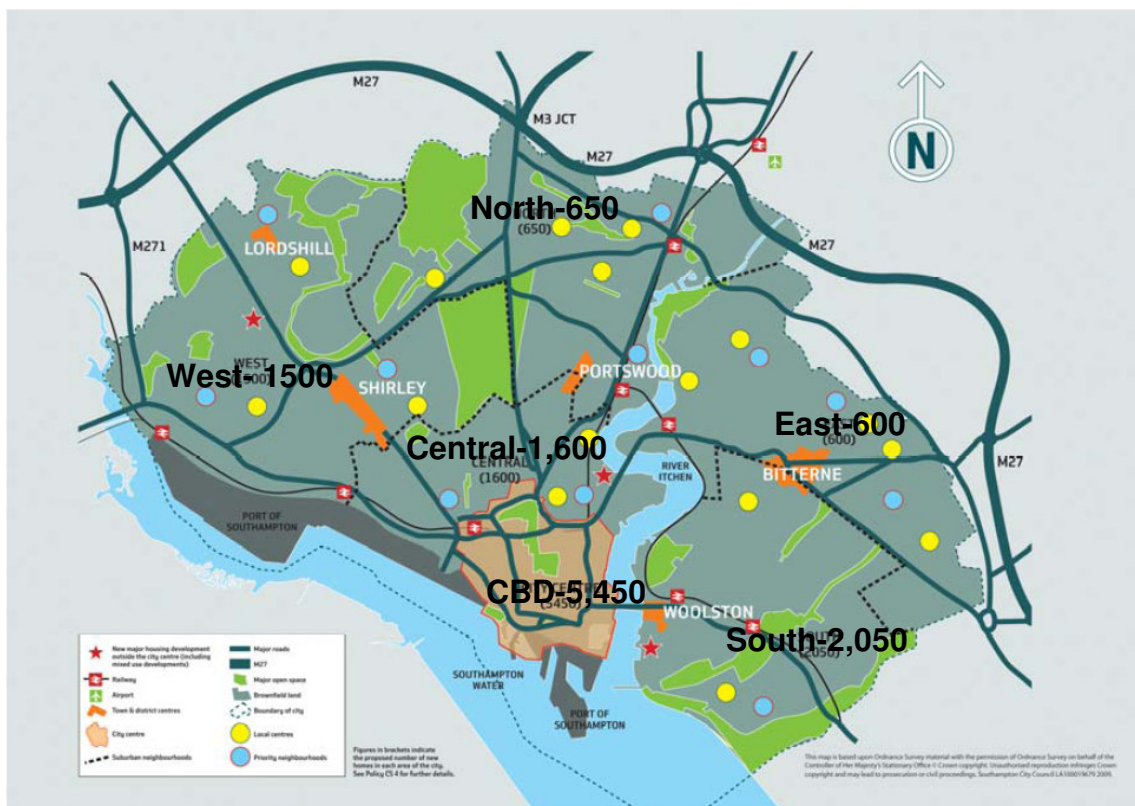

Figure 3 – Southampton residential development distribution¹⁴

This residential development is likely to be provided through estate regeneration, a number of medium-sized new developments (typically 50 to 500 residential units) on brownfield sites, and

¹⁴ Source: Southampton LDF Core Strategy

through more numerous infills and redevelopments of existing smaller sites. Infills and small-scale development will be particularly important in delivering the 1,300 units on unallocated sites.

Consequently, if much of this development is provided through multiple small sites, the risk of cumulative parking impacts is increased if Parking Standards do not address small sites.

It is not currently clear how many of these residential units will be houses and how many will be flats, although housing development in Southampton over the last decade has been heavily focused on flats. In the south Hampshire sub-region, the proportion of residential completions that were flats rose from 29% in 2000 to 75% in 2006¹⁵. Current trends and market conditions, together with the drive for higher residential densities, suggest that a majority of residential completions in future will continue to be flats.

3.4. Future Non-residential development

Around 579,000m² of non-residential development is proposed in the LDF Core Strategy¹⁶, of which around 85% (mostly offices and retail) will be provided in the city centre area, where this document's parking standards do not apply. The remaining 89,000m² of employment land is proposed to be split across the following zones (see **Figure 3** for zone boundaries):

- North - 4,000m²
- South - 29,000m²
- East - 1,000m²
- West - 55,000m²

Economic development (eg industrial and warehousing uses) in the area this SPD applies to is likely to be primarily focused on sites adjacent to the docks and key transport links and at sites on the banks of the River Itchen. There are a few other economic development sites scattered around the city. Limited retail development may be provided at other locations, including within various mixed use developments which are proposed.

Please refer to the [Proposals Map](#)¹⁷ for full details on the location of designated economic development sites.

There may also be occasional small-scale applications for other non-residential, non-employment developments. The Parking Standards and guidance in this SPD will apply to any new proposals for provision of the described non-residential development.

¹⁵http://www.seeda.co.uk/_publications/Housing_type_and_size_in_the_South_East___Full_Report___2007_1.pdf

¹⁶ Southampton LDF Core Strategy

¹⁷ Southampton Local Plan Review Adopted Proposals Map.

http://www.southampton.gov.uk/Images/Southampton%20Proposals%20Map%20150dpi%20with%20watermarks_tcm46-160933.pdf

3.3 Controlled Parking Zones (CPZs)

Controlled residential parking zones currently exist in the following areas:

- In the vicinity of Southampton University;
- In the Vicinity of Southampton General Hospital; and
- Areas around the periphery of the city centre, and in areas affected by matchday parking problems near St Marys Stadium.

Most of these CPZs exist to address parking overspill caused by major travel generators. The Parking Standards in *Section 4* do not permit reliance upon on-street parking within CPZs for any new developments. *Figure 4* shows the extents of CPZs based on the plan of Southampton's Traffic Regulation Orders.

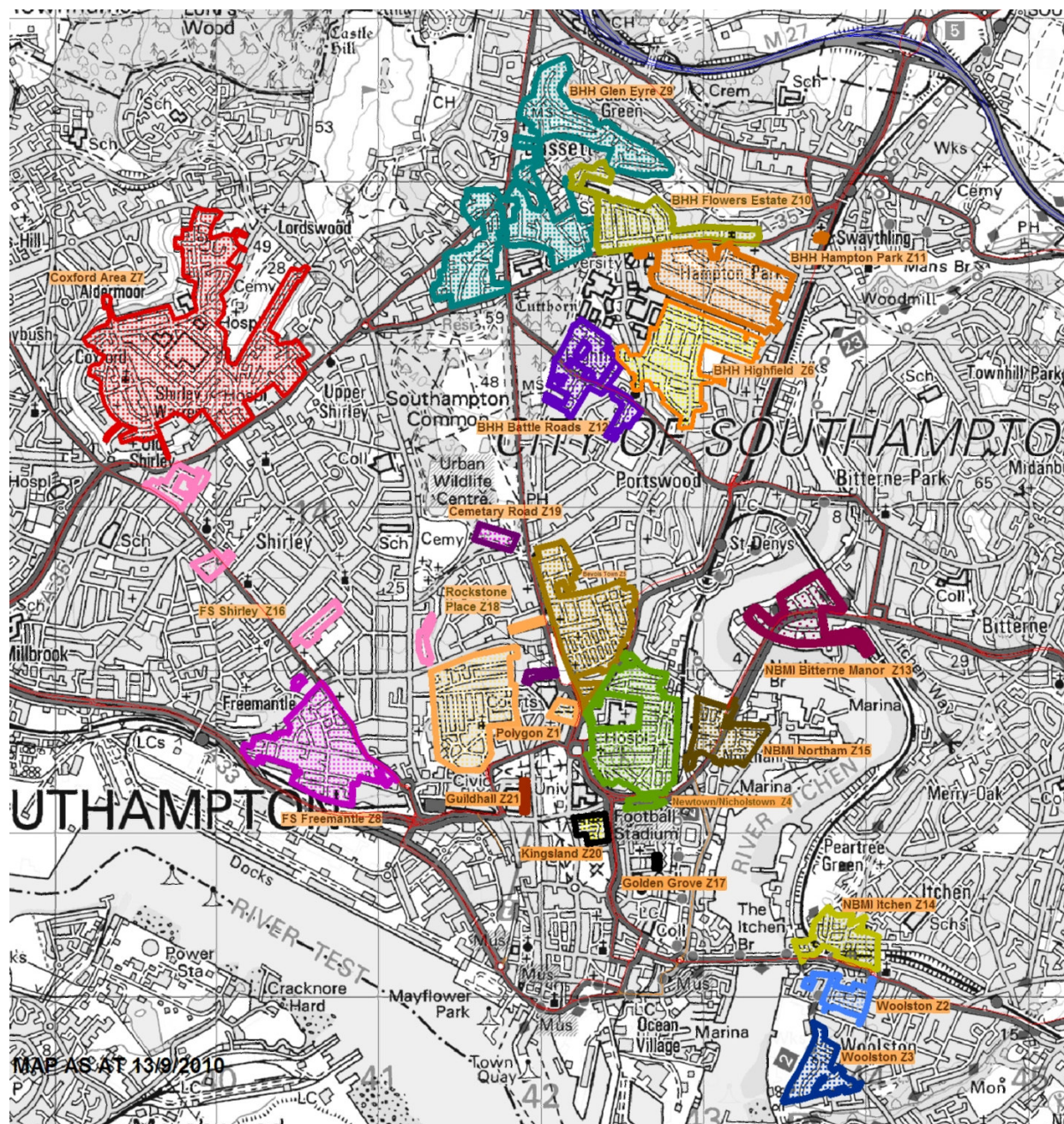

Figure 4- Controlled Parking Zones (CPZs) in Southampton, 2011

3.5 Research and experience in Southampton

Extensive research has been undertaken in support of the development of these parking standards. This has included reference to a considerable number of publications on the following topics:

- Future trends for transport;
- Parking policies and guidance;
- The relationship between parking and mode choice;
- Technical standards and design for parking;
- Environmental considerations for parking;
- Public realm for residential areas; and
- Other local authorities Parking Standards documents.

A full list of all the documents which have been considered in the development of this document is included in the Bibliography (*Section 10*).

Halcrow Consultancy was commissioned to undertake a review of Southampton's parking standards and make recommendations for future parking standards. Some of these recommendations have been carried forward in this document.

General feedback on the Local Plan Review (March 2006) parking standards from developers, the public, Southampton City Council Members and Officers, and other stakeholders stated that these Parking Standards for residential developments were too restrictive and had led to problems with parking due to developments in some instances.

Southampton City Council Staff carried out testing of the Parking Standards contained within this SPD through a study of whether these Parking Standards, if the maximum provision has been taken up by developers, would have solved parking difficulties at ten known "problem sites" in Southampton. This study suggests that at most of these sites, the Parking Standards contained in this SPD would have been adequate to reduce parking overspill and would also have led to improved design of parking at these sites, compared to the actual situation at these locations.

3.6 Justification for the standards set out

Following the research described above, we have decided to relax our Parking Standards relative to those set out in the Local Plan Review (March 2006).

The parking standards set out enable developers to provide more parking at sites in less accessible areas than they previously were able to, but still restricts the amount of parking that can be provided in more accessible areas to encourage more efficient use of land and higher development densities which will encourage sustainable travel patterns.

The differential between "high" accessibility and "standard" accessibility area parking provision has been reduced compared to the previous parking standards. The following bullet points help explain the rationale behind these parking standards.

- Parking restrictions at trip destinations (eg shops, offices) are likely to be more effective at encouraging use of non-car modes than restrictions at trip origins¹⁸
- High car ownership levels (average of over 1 car per dwelling in the city) and multiple occupancy of some residential properties increases pressure on on-street parking, and these trends are unlikely to be reversed in the short to medium term. Limited parking provision for development adjacent to residential areas may exacerbate these problems.
- Excessively restrictive parking standards may make the city less attractive to developers, making delivery of LDF core strategy development (and associated economic development and planning condition income) more difficult to achieve. These standards are similar to those of surrounding authorities such as Eastleigh.
- There is some evidence that edge-of centre residential areas are increasingly being used by commuters who park and walk to the city centre, increasing pressure on parking supply in this area.
- Reduced levels of on-street parking (through more relaxed parking standards) would make delivery of cycle and bus priority infrastructure more easily achievable.

¹⁸ Marsden, GR (2006) The evidence base for parking policies: a review. Transport Policy 13(6), pp.447-457. Available online: http://eprints.whiterose.ac.uk/2023/2/ITS15_The_evidence_base_for_parking_policies_UPLOADABLE.pdf

4. Car Parking Standards

4.1 Accessibility areas map

Figure 5 overleaf identifies which areas are deemed to be “standard accessibility” and which areas are deemed to be “high accessibility”.

The areas deemed as having “high accessibility” will be:

- Within 4 minutes walk (300 metres straight-line distance¹⁹) of a bus route served by a bus on average every 3 minutes or less in each direction (20 or more buses per hour per direction) in the weekday daytime ;

And/ or

- Within 500m straight-line distance of Southampton Central Railway Station.

For a high resolution version of this plan or to download the zone boundaries in Mapinfo TAB format, please go [to this weblink²⁰](#).

Please note that the accessibility areas plan in *Figure 5* is not related to the PTAL maps used in the LDF Core Strategy. The two maps are unrelated.

¹⁹ Assumes an average walking speed of 4.5km/hr. This is broadly in line with average pedestrian walking speeds established by academic research, eg Aspelin, 2009 (accessible online http://www.westernite.org/datacollectionfund/2005/psu_ped_summary.pdf)

²⁰ [Weblink for hi-res accessibility zones plan](#) to be added here

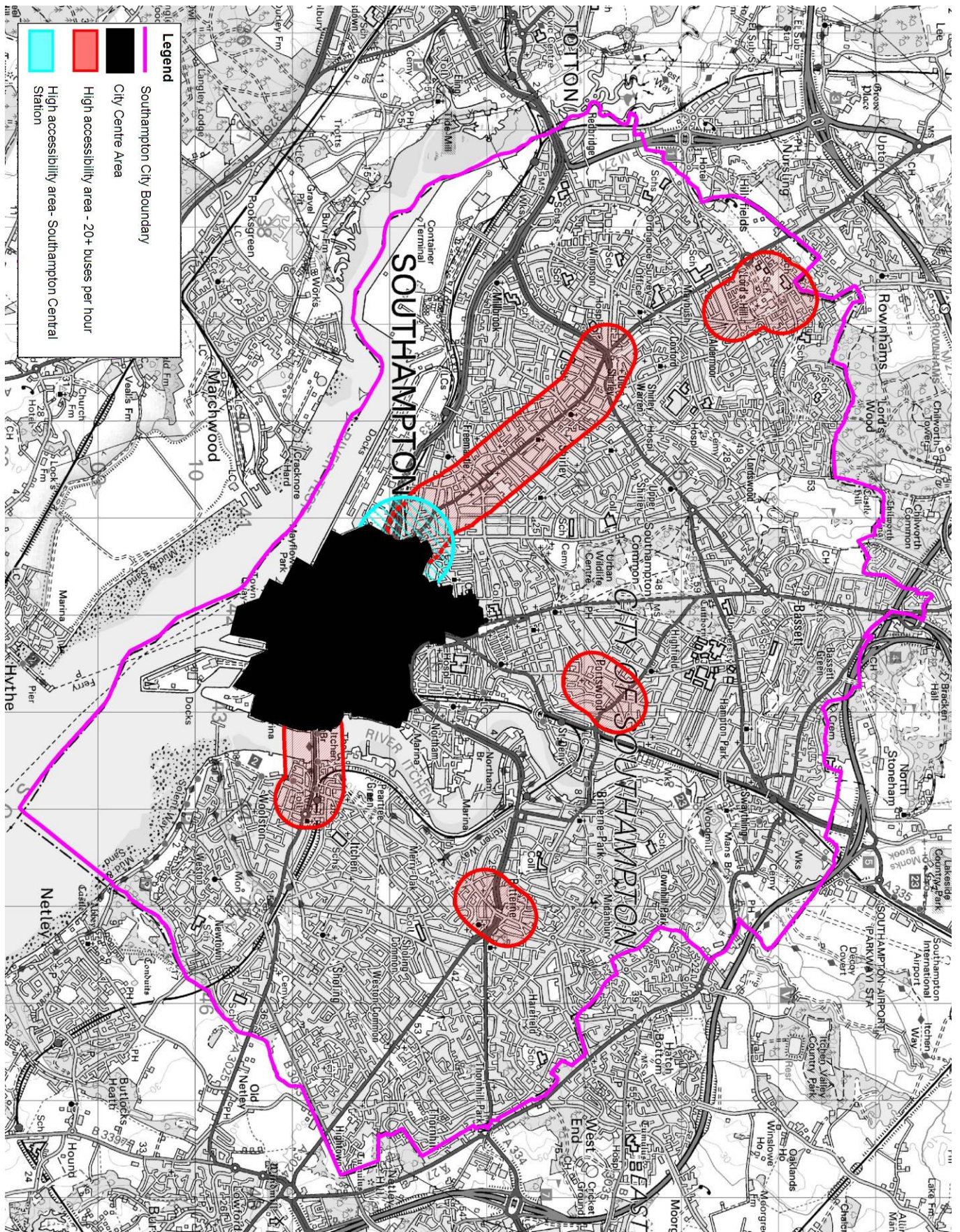

Figure 5: Plan of standard and high accessibility zones, June 2011

4.2 Residential development parking

4.2.1 Maximum parking standards

Table 1 sets out the maximum parking that may be provided at new residential developments.

Table 1: Residential parking standards

C3 Residential type	Maximum permitted parking provision	
	Maximum provision	Maximum provision (high accessibility area)
Bedsit/ 1 bed	1 space	1 space
2 beds	2 spaces	1 space
3 beds	2 spaces	2 spaces
4+ beds	3 spaces	2 spaces
Sheltered accommodation	1 space	1 space

4.2.2. Notes on Table 1

1. These parking standards DO NOT apply to class C4 Homes of Multiple Occupancy (HMOs). Parking standards for new and conversion HMOs will be set out in the HMOs SPD to be adopted in March 2012.
2. Provision of less than the maximum parking standard is permissible. Developers must demonstrate that the amount of parking provided will be sufficient, whether they provide the maximum permissible amount, or a lower quantity.
3. This parking may be provided via on- and off-street parking subject to the conditions and recommendations below. A combination of provision is recommended for many developments, as per guidance set out in Manual for Streets.
4. Research shows that residents prefer off-street parking, and reduced levels of on-street parking may remove a contributory factor in many Personal Injury Accidents in residential areas. Therefore off-street parking should make up the majority of parking provision for most larger developments.
5. However on-street parking will count towards parking provision at a site, if the criteria in Table 2 are satisfied.

Table 2: Criteria where on-street parking may count towards parking provision for development

Peak hour two way traffic flow on road/ street			
Conditions	<100 veh/hr	100 to 500 veh/hr	>500 veh/hr
	A. The street/road is not within an existing Controlled Parking Zone (CPZ);	A. The street/road is not within an existing Controlled Parking Zone (CPZ);	For roads and streets with peak traffic flows in excess of 500 vehicle movements per hour, the decision on whether on street parking can contribute to parking provision will be assessed by Southampton City Council on a case-by-case basis.
	B. The street/road is not on an existing bus route	B. The street/road is not on an existing bus route;	
	C. The street/road is not on a designated strategic cycle network link or planned link	C. The street/road is not on a designated strategic cycle network link or planned link	
	D. There are no objections to provision through on-street parking from statutory consultees including the emergency services	D. There are no objections to provision through on-street parking from statutory consultees including the emergency services	
	E. The developer has demonstrated through parking surveys, accumulation estimation, etc, that use of on-street parking will not lead to demand exceeding supply of on-street parking	E. The developer has demonstrated through parking surveys, accumulation estimation, etc, that use of on-street parking will not lead to demand exceeding supply of on-street parking	
	F. Effective carriageway width of the street/road is 5.5 metres or greater, in order that one-way traffic may pass with parked vehicles on one side of the road	Effective carriageway width of the street/road is 7 metres or greater, in order that two-way traffic may pass with parked vehicles on one side of the road	

6. If the carriageway widths cannot be met, alterations to existing carriageways to provide sufficient width are permitted subject to agreement of Southampton City Council and continued provision of adequate footway widths and re-provision of any lost green space.
7. For residential developments providing up to a total of five bedrooms across all dwellings, the entire parking provision may be met through on-street provision subject to the above criteria being met. For developments providing more than five bedrooms, some off-street parking is expected.
8. Square and angled parking bay sizes must not be less than 5m x 2.4m. Parallel parking bay sizes must not be less than 6m x 2.5m. These bay sizes are sufficient to allow use by typical vehicles up to large family estate car size²¹.
9. Research has shown that in many developments, less than half of all garages are used for car parking, instead being used for storage. Whether garages will count toward parking provision at a development will be decided upon on a case-by-case basis, as per Manual for Streets Guidance. In instances when garages do count towards parking provision, they must be sized at least 6m x 3m, sufficient to contain a typical car and provide some storage space for bicycles. Double garages must be sized at least 6m x 5.5m in order to count towards on-site parking provision.
10. Car ports, undercroft parking, etc, of dimension 5.5x 2.9m per bay or greater will count towards parking provision.
11. Allocated parking spaces can only legally be provided on off-highway car parking. Provision of allocated parking spaces may reduce the efficiency of parking space use in many circumstances- but can help reduce difficulties due to competition for parking spaces. Whether parking is allocated or not is left to the discretion of developers, but to meet demand for visitor parking and overspill, a maximum of 80% of the parking provision may be allocated, allowing 20% unallocated to cater for visitors, servicing, etc.

²¹ eg Ford Mondeo 4.8m; VW Passat 4.7m

12. All parking provision should be in line with recommendations in the Residential Design Guide SPG, to ensure that parking designed in a manner that encourages its correct use.
13. In order to future-proof parking design for future vehicle types, developers are encouraged to provide Electric Vehicle (EV) charging facilities for at least some bays at time of build. If these facilities are not provided at the time of build, developers are required to design parking arrangements and electrical connections in such a way that EV charging points can be retrofitted to parking bays without unreasonable levels of disruption.
14. A way of achieving this would involve routing an empty cable conduit under one end of parking bays in a row, and ensuring this conduit also connects to the electrical mains, such that at a later date, a power supply cable could be fitted inside the conduit and above-ground charge points then installed with a minimum of excavation of parking bays. In residential developments, developers should ensure that power supplies are available inside a building wall near to any parking bay so that the relevant charging equipment can be fitted without requiring large amounts of additional wiring. Please refer to the Transport for London Guidance for implementation of electric vehicle charging infrastructure for more guidance²².
15. All parking should be part of a Sustainable Urban Drainage System (SUDS) unless there are overriding technical reasons why this cannot be done.
16. Permeable surface materials should be used wherever possible to reduce surface water runoff²³.
17. The design of all parking areas should include appropriate landscaping. All parking areas should include tree and shrub planting unless their absence can be justified by the small size of the parking area, or the character of the surrounding area.
18. For sheltered housing, developers should consider inclusion of parking space for mobility scooters if this is likely to be required.

²² <http://www.newride.org.uk/downloads/EVCP-Guidance-Apr10.pdf>

²³ For more details on permeable surfacing of paved areas, please refer to the following link:
<http://www.communities.gov.uk/publications/planningandbuilding/pavingfrontgardens>

4.3 Non-residential development parking

Tables 3 to 9 below sets out the maximum parking that may be provided at non-residential developments of the types specified.

Table 3: Maximum parking standards for industrial & warehousing land uses

Use Class	Maximum permitted no of parking spaces	
	Maximum provision	Maximum provision (high accessibility area)
B1 Business-offices	1 per 30m ² ■	1 per 200m ²
B1 Business-light industrial use	1 per 45m ²	1 per 300m ²
B2 General Industry	1 per 45m ²	1 per 300m ²
B8 Storage & Distribution/ Warehouses	1 per 90m ²	1 per 600m ²
B8 Wholesale Cash & Carry*	1 per 30m ²	1 per 30m ²

Table 4: Maximum parking standards for office land uses

Use Class	Maximum permitted no of parking spaces	
	Maximum provision	Maximum provision (high accessibility area)
B1 Business-offices	1 per 30m ² ■	1 per 200m ²
B1 Business-light industrial use	1 per 45m ²	1 per 300m ²
B2 General Industry	1 per 45m ²	1 per 300m ²
B8 Storage & Distribution/ Warehouses	1 per 90m ²	1 per 600m ²
B8 Wholesale Cash & Carry*	1 per 30m ²	1 per 30m ²

Table 5: Maximum parking standards for retail land uses

Use Class	Maximum permitted no of parking spaces	
	Maximum provision	Maximum provision (high accessibility area)
A1 Shops- Covered Retail area	1 per 20m ²	1 per 66m ²
A1 Shops- Uncovered retail area	1 per 30m ²	1 per 100m ²
Convenience stores up to 500M ² GFA*	1 per 30m ²	1 per 50m ²
Convenience supermarkets up to 2500M ² GFA*	1 per 18m ²	1 per 30m ²
Food Retail over 2500M ² GFA	1 per 14m ² ■	1 per 25m ²
A2 Financial/ professional services (eg banks)	1 per 20m ²	1 per 130m ²
Non-food comparison warehouse*	1 per 30m ²	1 per 50m ²
Garden Centre*	1 per 25m ²	1 per 45m ²

Marinas	1.5 spaces per berth	0.5 spaces per berth
Theatres	1 space per 5 seats	1 space per 15 seats

Table 6: Maximum parking standards for health & education uses

Use Class	Maximum permitted no of parking spaces	
	Maximum provision	Maximum provision (high accessibility area)
D1 Primary & Secondary Schools	1.5 per classroom	0.75 per classroom
Higher & Further Education *	1 per 2 staff + 1 per 15 students (see note 1) ■	1 per 4 staff + 1 per 30 students (see note 1)
Day nurseries/ Creches/ Day centres	3 per 4 staff	3 per 8 staff
C2 Residential Schools	Level to be determined via transport assessment	
Hospitals	Level to be determined via transport assessment	
D1 Health Centres/ Doctors Surgeries/ Veterinary Surgeries etc	3 per consulting room	1.5 per consulting room
Nursing Homes	1 per 4 beds	1 per 10 beds

Table 7: Maximum parking standards for cafe, restaurant & takeaway land uses

Use Class	Maximum permitted no of parking spaces	
	Maximum provision	Maximum provision (high accessibility area)
A3 Cafés / restaurants- covered area	1 per 20m ²	1 per 200m ²
A3 Cafés / restaurants- uncovered area	1 per 30m ²	1 per 300m ²
A4 Public Houses- covered area	1 per 20m ²	1 per 200m ²
A4 Public Houses- uncovered area	1 per 30m ²	1 per 300m ²
A5 Takeaways- covered area	1 per 20m ²	1 per 200m ²
A5 Takeaways-uncovered area	1 per 30m ²	1 per 300m ²

Table 8: Maximum parking standards for hotels, sports & leisure uses

Use Class	Maximum permitted no of parking spaces	
	Maximum provision	Maximum provision (high accessibility area)
C1 Hotels, Boarding & Guesthouse	1 per bedroom	1 per 3 bedrooms
D2 Cinemas and conference facilities*	1 space per 5 seats [■]	1 space per 15 seats
Bowling Alleys	3 per lane	1 per lane
Sports Halls	1 per 10m ²	1 per 30m ²
Health Clubs	1 per 5 seats plus 1 per 10m ² of playing area	1 per 15 seats plus 1 per 30m ² of playing area
Swimming Pools	1 per 5 seats plus 1 per 1m ² of pool area	1 per 15 seats plus 1 per 3m ² of pool area
Tennis Courts	3 per court	1 per court
Squash Courts	2 per court	0.6 per courts
Playing Pitches	12 per hectare of pitch	4 per hectare of pitch
Sports Stadia*	1 per 15 seats (see note 2) [■]	1 per 45 seats (see note 2)
D2 Other than cinemas, conference facilities and stadia*	1 per 22m ² [■]	1 per 66m ² [■]

Table 9: Maximum parking standards for all other uses

Use Class	Maximum permitted no of parking spaces	
	Maximum provision	Maximum provision (high accessibility area)
D1 Places of Worship	1 per 5 fixed seats and 1 per 10m ² of open hall	1 per 10 fixed seats and 1 per 20m ² of open hall
Railway stations; Park & Ride Sites*	Level to be determined via transport assessment	
Car workshops-staff parking	1 space per 45m ²	1 space per 130m ²
Car workshops-customer parking	3 per service bay	3 per service bay
Car Sales- Staff Parking	1 per 2 full time staff	1 per 6 full time staff
Car sales- Customer Parking	1 per 10 cars	1 per 10 cars
All other uses	Level to be determined via transport assessment	

Key to symbols and notes within Tables 3 to 9

■ This value is at the stated National maximum provision in PPG13¹

GFA: Gross Floor Area

Note 1: The standard for students relates to the total number of students attending an educational establishment, rather than full-time equivalent figures.

Note 2: For stadia, sufficient coach parking should be provided to the satisfaction of Southampton City Council, and be treated separately from car parking. Coach parking should be designed and managed so that it will not be used for car parking.

4.3.1 Additional Notes on *Tables 3 to 9* - non-residential parking standards

1. Provision of less than the maximum parking standard is permissible. Developers should demonstrate that the amount of parking provided will be sufficient, whether they provide the maximum permissible amount, or a lower quantity.
2. Maximum standards are considerably reduced in high accessibility areas, in line with policy, to encourage more efficient land use. Also, as these non-residential uses are likely to be the destination of a trip (rather than an origin), availability of parking at these destinations is likely to have a strong influence on the mode used to access these destinations, hence these standards are designed to encourage modal shift.
3. Whether on street parking can contribute to total parking provision for non-residential developments will be assessed by Southampton City Council on a case-by-case basis.
4. Square and angled parking bay sizes must not be less than 5m x 2.4m. Parallel parking bay sizes must not be less than 6m x 2.5m. These bay sizes are sufficient to allow use by typical vehicles up to large family estate car size²⁴. It is recommended that for non-residential developments, up to 10% of bays be sized for larger vehicles (suggested bay size 5.5x2.9m) however these larger bays must be located furthest from the main entrance to the development.
5. Underground and undercroft parking, etc, of dimension 5.5x 2.9m per bay or greater will count towards parking provision.
6. For some of the use types described in *Tables 3 to 9*, allocated parking spaces may be appropriate or desirable. Allocated parking spaces can only legally be provided on off-highway car parking. Provision of allocated parking spaces may reduce the efficiency of parking space use in many circumstances- but can help reduce difficulties due to competition for parking spaces. Whether parking is allocated or not is left to the discretion of developers, but it is expected that a sufficient quantity of unallocated parking will be made available to cater for visitors, servicing, etc.
7. All parking and access provision should be in line with recommendations in the design guidance appropriate to the street/road type that the development is located on:
8. For primarily residential streets, designs should follow principles set out in Manual for Streets and the Southampton City Council Residential Design Guide SPG chapter on access and parking;
9. For mixed use streets (residential and other uses) and main corridors in urban areas, designs should follow principles set out in Manual for Streets and/ or Manual for Streets 2 and the Southampton City Council Development Design Guide SPG and Streetscape Manual SPG; and
10. For roads outside of urban areas and in locations where the sole function of the highway is as a transport corridor, Design Manual for Roads and Bridges is the appropriate design guidance. In an urban area such as Southampton, there are very few locations to which this design standard would apply.
11. In order to future-proof parking design for future vehicle types, developers are encouraged to provide Electric Vehicle (EV) charging facilities for at least some bays at time of build. If these facilities are not provided at the time of build, developers are required to design parking arrangements and electrical connections in such a way that EV charging points can be retrofitted to parking bays without unreasonable levels of disruption.

²⁴ eg Ford Mondeo 4.8m; VW Passat 4.7m

12. A way of achieving this would involve routing an empty cable conduit under one end of parking bays in a row, and ensuring this conduit also connects to the electrical mains, such that at a later date, a power supply cable could be fitted inside the conduit and above-ground charge points then installed with a minimum of excavation of parking bays. In residential developments, developers should ensure that power supplies are available inside a building wall near to any parking bay so that the relevant charging equipment can be fitted without requiring large amounts of additional wiring. Please refer to the Transport for London Guidance for implementation of electric vehicle charging infrastructure for more guidance²⁵.
13. All parking should be part of a Sustainable Urban Drainage System (SUDS) unless there are overriding technical reasons why this cannot be done.
14. Permeable surface materials should be used wherever possible to reduce surface water runoff²⁶.
15. All parking should be part of a Sustainable Urban Drainage System (SUDS) unless there are overriding technical reasons why this cannot be done. Also, all parking areas should be constructed using rainwater-permeable surface materials to minimise runoff generation²⁷.
16. The design of all parking areas should include appropriate landscaping. All parking areas should include tree and shrub planting unless their absence can be justified by the small size of the parking area, or the character of the surrounding area.
17. For some developments, shared use of parking areas for users of more than one development/destination may be possible. For example, many evening leisure destinations rely on public parking that is used by retail and employment development visitors and employees during the day, without conflict.
18. This is a very efficient use of land for parking, and such shared use will be encouraged by Southampton City Council in instances where developers can demonstrate that shared use will not result in conflict or demand beyond parking supply. In instances where the viability of shared use can be demonstrated, Southampton City Council will permit development with appropriate reductions in dedicated parking provision.
19. Where retail stores are grouped together on the same site, account will be taken of the common parking provision and accessibility to other stores, subject to consideration of ownership.

²⁵ <http://www.newride.org.uk/downloads/EVCP-Guidance-Apr10.pdf>

²⁶ For more details on permeable surfacing of paved areas, please refer to the following link:
<http://www.communities.gov.uk/publications/planningandbuilding/pavingfrontgardens>

4.4 Car Parking for disabled/ less mobile people

The requirements set out in *Table 10* regarding parking for disabled and less mobile people must be observed. These requirements are unchanged from the Local Plan values.

Table 10- parking standards for disabled/ less mobile people

Location	Threshold	Minimum number of spaces	Percentage of spaces to be provided as disabled persons parking
Places of employment	Under 20 spaces	No requirement	No requirement
	Over 20 spaces	2	5%
Developments where public parking is provided	Between 20 and 200 spaces	3	5%
	Over 200 spaces	4	5%
Residential developments	Under 10 spaces	No requirement	No requirement
	Over 10 spaces	1	5%

4.4.1 Notes on *Table 9- parking standards for disabled/ less mobile people*

1. These are minimum numbers/ proportions of the total parking provision (in line with maxima set out elsewhere in this document) that must be suitable for use by disabled and less mobile people. Developers are free to provide a higher proportion of parking suitable for disabled and less mobile people should they wish, and at some types of developments, eg care homes, etc, this would be prudent.
2. Bays suitable for use by disabled and less mobile people should be longer and wider than the minimum bay sizes set out. They should enable easy and safe access from the side and rear for wheelchairs. It is recommended that at least an additional 1.0m is added to the length and width of the minimum parking bay.
3. These bays should be clearly marked as being for disabled / less mobile users with the International Symbol for Access. The safety zone/ aisle between bays should also be marked with hatching, coloured surfacing or similar.
4. Dropped kerbs should be provided to enable access from disabled parking bays to/from the footway

Please refer to *Section 10* for recommended design guidance references for parking for disabled and less mobile people.

4.5 Commercial and Passenger Carrying Vehicle Parking Maximum Standards

Maximum parking provision for commercial vehicles and PCVs at developments is set out in this section.

1. For industrial/warehouse (B1/B2/B8) uses:

- For the first 2000m², one lorry space per 500m² rounded up.
- For development floorspace above the first 2000m², one lorry space per 1,000m²

2. For retail uses:

- Applicant must prove that deliveries can be made without causing undue disruption or safety problems on the highway network.

3. For other uses generating operational lorry and van movements:

- Applicant to demonstrate that the proposed provision of parking will be adequate for the planned level of lorry/van activity at the development.

4. For uses likely to generate coach traffic:

- Applicant to demonstrate that the proposed provision of coach/ PCV parking will be adequate for the planned level of coach/PCV activity.

5. Parking bay sizes should be at least:

- 7.5m x 3.5m for vans & minibuses²⁸
- 12.0m x 3.5m for rigid trucks and buses/ coaches
- 17.0m x 3.5m for articulated trucks

²⁸ To cater for the trend of increasingly long vans, eg Mercedes Sprinter up to 7.3m; Ford Transit up to 6.4m

5. Cycle Parking Standards

Tables 11 and 12 set out the minimum cycle parking that must be provided at new developments. Developers may provide additional cycle parking above this level should they wish or should the need be demonstrated.

Table 11: Non-residential parking standards

Use Class	Parking Type	Minimum Cycle Parking Provision
Shops (A1)	Long Stay	Greater of 1 space per 10 employees (part and full-time) or 1 space per 200 m ² GFA
	Short Stay	1 space per 100 m ² GFA
Financial & Professional Services (A2)	Long Stay	Greater of 1 space per 10 employees (part and full-time) or 1 space per 200 m ² GFA
	Short Stay	1 space per 100 m ² GFA
Food & Drink (A3, A4, A5)	Long Stay	Greater of 1 space per 10 employees (part and full-time) or 1 space per 200 m ² GFA
	Short Stay	1 space per 100 m ² GFA
Business (B1)	Long Stay	Greater of 1 space per 10 employees (part and full-time) or 1 space per 100 m ² GFA. Spaces must be under cover, secure, and located where overlooked
	Short Stay	1 space per 250 m ² GFA
General Industry (B2)	Long Stay	Greater of 1 space per 10 employees (part and full-time) or 1 space per 250 m ² GFA
	Short Stay	1 space per 500 m ² GFA
Storage & Distribution (B8)	Long Stay	1 space per 500 m ² GFA
	Short Stay	1 space per 1000 m ² GFA
Hotels, Boarding & Guest Houses (C1)	Long Stay	1 space per 10 employees
	Short Stay	1 space per 10 beds
Residential care and other care establishment (C2)	Long Stay	1 space per 10 employees (minimum 1 space provided)
Hospitals (C2)	Long Stay	1 space per 10 employees, under cover, secure, and located where overlooked
	Short Stay	1 space per 10 beds
Convalescent/Nursing Homes (C2)	Long Stay	1 space per 10 employees (minimum 1 space provided)
Sheltered Homes (C3)	Long Stay	1 space per 10 employees (minimum 1 space provided)
Primary Schools	Long Stay	1 space per 15 students and 1 space per 10 employees under cover, secure, and located where overlooked
Secondary Schools	Long Stay	1 space per 4 students and 1 space per 10 employees under cover, secure, and located where overlooked.
Further Education Colleges, Universities	Long Stay	1 space per 4 students and 1 space per 10 employees under cover, secure, and located where overlooked.
Day nurseries/Playgroups/Infant Schools	Long Stay	1 space per 10 employees (minimum 1 space provided)
Other Leisure Facilities and Places of Public Assembly, eg sports grounds, playing pitches, etc	Short Stay	The required level of parking provision will be decided on a case-by-case basis

Table 12: Residential parking standards

Use Class	Parking Type	Minimum Cycle Parking Provision
Houses (C3)	Long Stay	1 secure space per unit ²⁹
Flats (C3)	Long Stay	1 secure space per unit ²¹
	Short Stay	1 space per 10 units

Notes on *Tables 11 and 12*:

1. Long Stay cycle parking is defined as covered and enclosed cycle parking, suitable for leaving bikes in all day and/or overnight, protecting bikes from rain, and providing a degree of security against theft or vandalism. Long stay parking is generally intended for residents and employees at employment sites.
2. Short Stay cycle parking is defined as open racks such as Sheffield Stands located in a well-observed location and near the entrance of the building they serve. Short stay parking is generally intended for visitors to shops, offices and residential sites.
3. Long and short stay parking must be located at ground level. Any cycle parking provided in underground car parks or above ground level will not count towards the required cycle parking provision.
4. Covered parking is taken to mean that cycles will not be exposed to rain or wind-blown rain when parked under cover
5. Secure parking is taken to mean that cycle parking is protected by a lockable door, security door (eg swipe card), is stored within an individual bike locker, or is stored in an arrangement which restricts access to cycle parking to authorised persons only.

²⁹ A garage will count as a secure cycle parking space so long as its dimensions are equal to or exceed those specified in Sections 4.1.2 / 4.2.1. Garages smaller than this minimum dimension will not be counted as either a car parking space or a secure cycle parking space.

5.1 Cycle parking design guidance

Providing well-located, safe, and secure cycle parking helps to encourage increased numbers of people to cycle. Inadequate cycle parking and storage facilities, conversely, can act as a barrier to uptake of cycling.

Consequently it is expected that in addition to provision of at least the minimum cycle parking provision specified in *Tables 11 and 12*, developers will ensure that cycle parking is designed and located in accordance with best practice set out in the documents below:

- Manual for Streets;
- Manual for Streets 2;
- Southampton City Council Development Design Guide SPG;
- Southampton City Council Residential design guide SPG;
- Southampton City Council Streetscape Manual SPG; and
- Sustrans/CTC Information Sheet FF37³⁰

All cycle parking should be:

- Conveniently located, adjacent to building entrances (preferably less than 50m between building entrance and cycle parking);
- Enjoy good natural observation;
- Be easily accessible from roads and/or cycle routes;
- Be well lit; and
- Be located such that it does not obstruct pedestrian and/or cycle routes.

All cycle parking (short and long stay) should be provided at ground level, rather than underground or at a level above normal ground level. Underground or upper level cycle parking will only be acceptable in exceptional conditions where it can be demonstrated that ground level provision is not practicable and safe/ accessible, and that alternative facilities can be provided within the building which meet all the other criteria for long stay cycle parking. Also, there should be direct access between cycle parking and a public right of way- it should not be provided in locations where it is necessary to carry a bicycle through a building in order to access the cycle parking.

Any cycle parking provision that is compliant with Code for Sustainable Homes³¹ guidance on cycle parking, and/or with BREEAM³² compliance requirements for office cyclist facilities, will be compliant with Southampton City Council cycle parking design guidance and provision standards.

³⁰ <http://www.sustrans.org.uk/assets/files/Info%20sheets/cycle%20parking%20info%20sheet.pdf>

³¹ http://www.planningportal.gov.uk/uploads/code_for_sustainable_homes_techguide.pdf

³² <http://www.breeam.org/index.jsp>

5.2 Basic recommendations for Short Stay Cycle Parking

Short stay parking should be located nearer to the building entrance than the nearest car parking, and in a location highly visible to people, to reduce threat of theft or vandalism.

Short stay parking should be provided using Sheffield type stands and variants of these, with recommended minimum dimensions set out in *Figure 6*. These stands need to be placed a minimum of one metre apart in order to enable easy use of the parking. Recommended layouts and dimensions for use in Southampton are set out in *Figure 7*. Obsolete “butterfly” design (wheel only) stands are not appropriate.

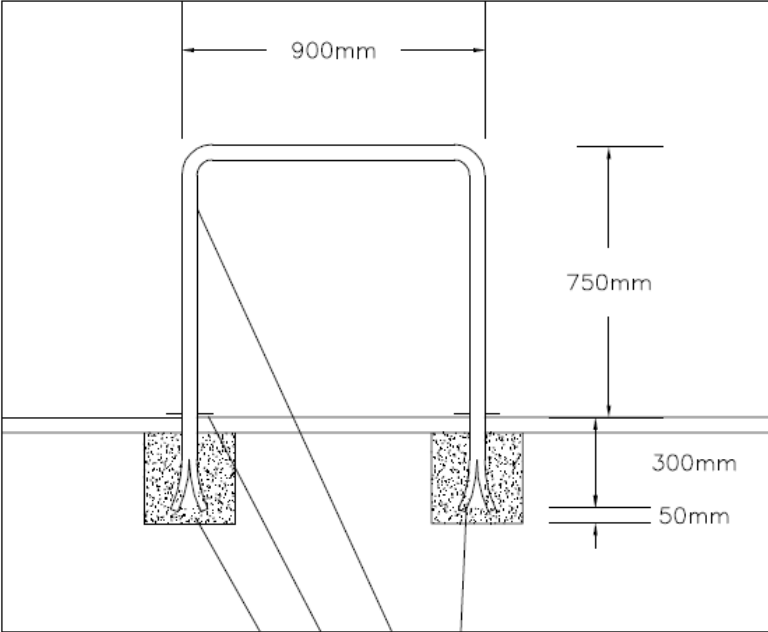

- Base of each leg to be ragged or have a 150mm square stainless steel plate welded.
- 50mm diameter polished stainless steel cycle stand set with the top bar level.
- 150mm dia. 3mm thick stainless steel ferrule supplied loose on each leg, to be epoxy resined to the footway.
- 300x300x300mm ST1 concrete footing.

Notes

- 1) Stainless steel to be marine grade 316 with polished finish to all surfaces.
- 2) Tube thickness to be 3mm minimum. Tube bends shall be to 150mm radius with no tube crushing.
- 3) Erection of stands in PCC flags shall be carried out such that the reinstatement is hidden beneath the stainless steel disc which shall be epoxy resined to the underlying surface.
- 4) In certain cases it may be appropriate to specify a cycle stand with flanged feet bolted at ground level. In this case consideration should be given to the security of the stand, the design of the fixings with respect to aesthetics, and the level of the ground surface. Design drawings should be presented for approval.

Figure 6: Southampton City Council Standard detail drawing for Sheffield Stand cycle parking

Layout 1 – Perpendicular To Kerb

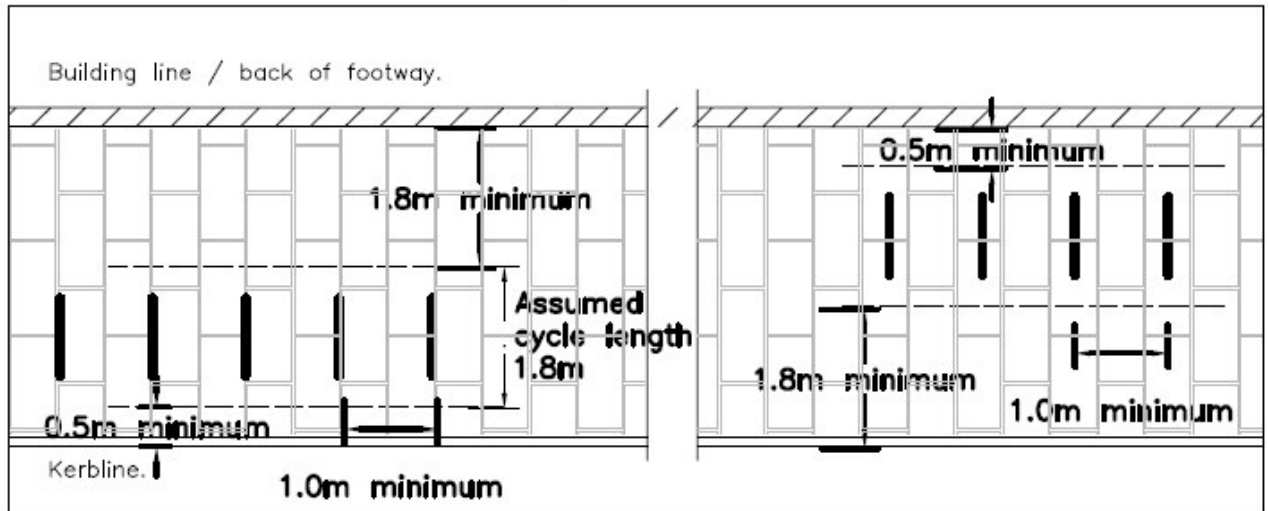

Layout 2 – Parallel To Kerb

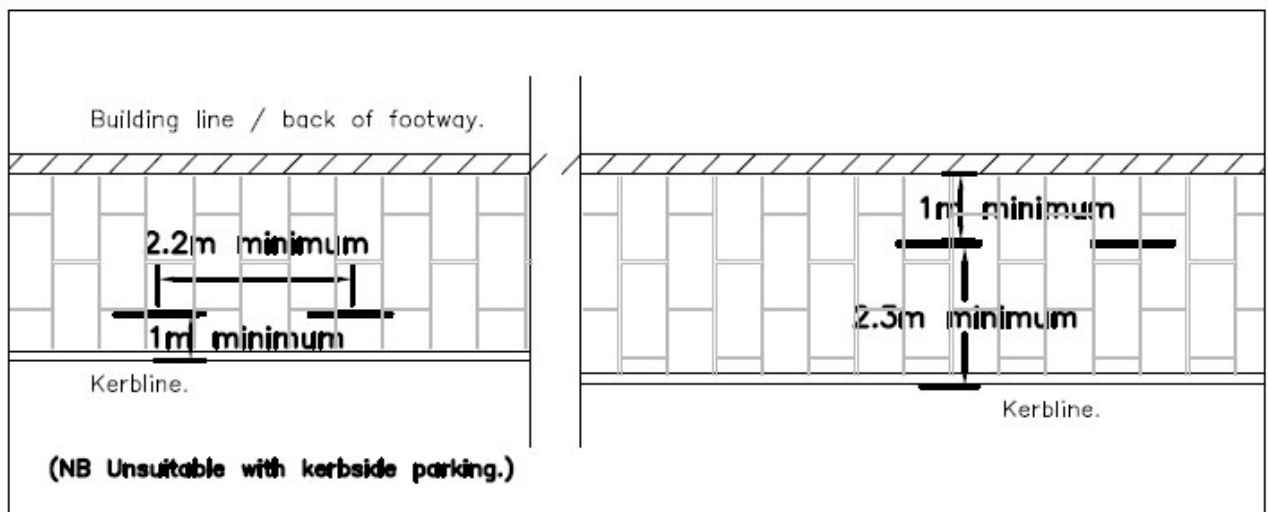

Layout 3 – Echelon

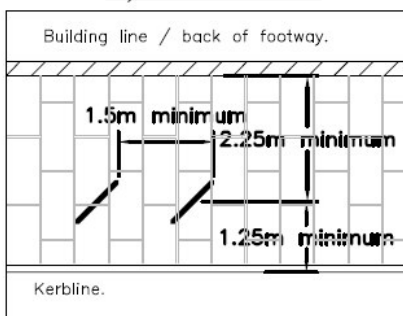

Notes

- When positioning cycle stands, consider the following points:-
- The effect on pedestrian movement – particularly blind and partially sighted.
 - The location in relation to adjacent street furniture.
 - The demand for cycle parking at the location at different times.
 - The apparent security of the location – an overlooked location is best.
 - The need for direction signing to the cycle stands.
 - The proximity of heavy traffic and dropped kerbs for access.
 - Legitimate access requirements including the emergency services.
 - The potential 'second function' to prevent footway parking.
 - The location of buried services.

Figure 7: Southampton City Council Standard detail drawings for short stay cycle parking layouts

5.3 Basic recommendations for Long Stay Cycle Parking

As per note 1 for *Tables 11 and 12*, all long stay parking must be covered and enclosed. This can mean storage within a dedicated part of a building with access to the outside, or provision of a covered shelter etc adjacent to a building.

Figures 8 and 9 provide sample dimensions of cycle stores using Sheffield stands that might be provided at smaller residential and/or non-residential developments.

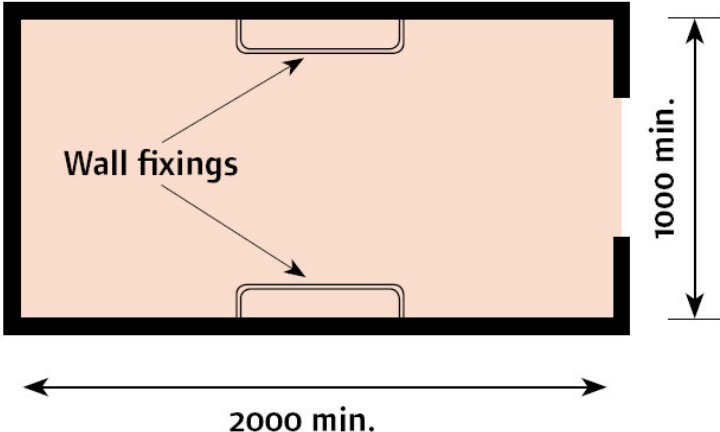

Figure 8: Plan of communal store for four cycles using Sheffield stands³³

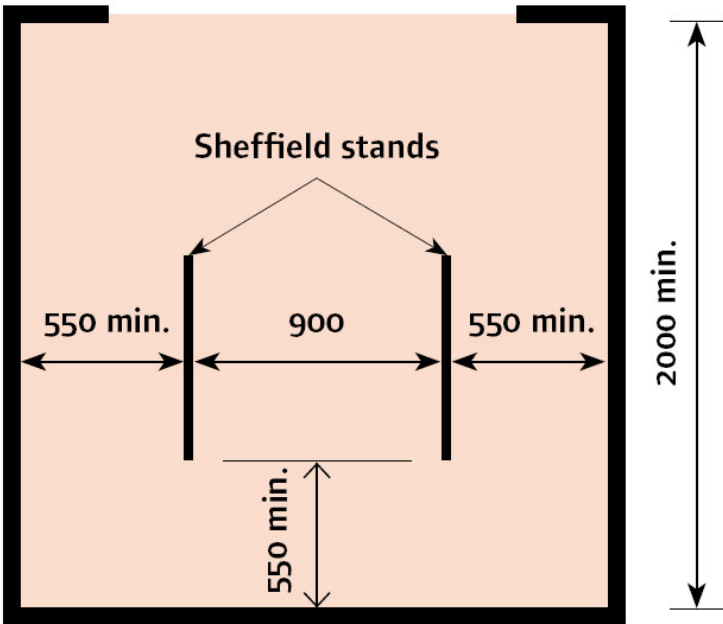

Figure 9: Plan of store for two cycles using wall fittings²³

Other types of stand such as secure cycle lockers and two-tier racks are also acceptable for certain long stay cycle parking situations.

For residential developments where a garage is provided, any garage that counts as a car parking space (ie exceeds 6m x 3m size) will also count as providing secure long stay cycle parking.

³³ Source: Manual for Streets

6. Powered Two Wheeler Parking

A minimum of one space designed for Powered Two Wheeler (PTW) parking must be provided per 25 car parking spaces.

Provision above this level is permitted and for some types of development where there are higher levels of PTW travel (eg Higher Education Colleges and Further Education establishments) provision above this level may be recommended.

Developers should also demonstrate that they have considered additional needs of PTW users, such as lockers and changing facilities.

7. Transport Assessments

Full Transport Assessments will be required for larger developments as follows:

- Residential (C3): Over 50 units
- Commercial (B1 & B2): Over 2,500m²
- Commercial (B8): Over 5000m²
- Retail (A1): Over 1000m²
- Education: Over 2500m²
- Health establishments: Over 2500m²
- Care establishments: Over 1000m² or 10 bedrooms
- Leisure & sports developments (general): Over 1000m²
- Leisure stadia, ice rinks, etc: Over 1,500 seats
- Miscellaneous commercial: Over 500m²
- All other types of larger development: Southampton City Council will decide if a Transport Assessment will be required on a case-by-case basis.

All developments falling below the Transport Assessments thresholds set out above will be required submit a less detailed Transport Statement document.

8. Travel Plans

Travel Plans, setting out measures and techniques which will be employed at developments to encourage more sustainable transport mode choice and travel behaviour (thus reducing demand for parking, as well as general demand on the highway network) will be required for developments as follows:

- A residential travel plan will be required for all residential developments of more than 100 units
- A residential travel plan may be required for residential developments of between 50 and 100 residential units. Whether or not a travel plan is required will be decided upon on a case-by-case basis
- All types of non-residential developments where there will be more than 50 employees (total of full time and part time employees) will be required to submit a Travel Plan
- All new health establishments or major expansions will require a Travel Plan to be produced
- All major leisure facilities will be required to produce a Travel Plan
- All primary and secondary schools will be required to produce a Travel Plan

For residential developments below 50 units and non-residential developments below the thresholds set out above, whilst submission of a Travel Plan is not required, it is encouraged. In some cases, Southampton City Council may be able to provide technical, practical and/or financial support to set up and monitor travel plans. Additionally, developers and businesses needing to implement a Travel Plan are invited to join the Southampton Travel Planners Forum, set up by SCC to promote Travel Planning and encourage dialogue between those implementing Travel Plans.

Developers submitting and implementing a suitable Travel Plan may use this to support reduced parking provision on a site compared to the site parking requirements without a Travel Plan.

Southampton City Council will assess suitability of Travel Plans for this purpose on a case-by-case basis. It is recommended that all Travel Plans should follow guidance set out in the following documents:

- “Making residential travel plans work: good practice guidelines for new development”- DfT, 2005³⁴
- “The essential guide to Travel Planning”- DfT, 2008³⁵

³⁴ “Making residential travel plans work: good practice guidelines for new development”- DfT, 2005- ONLINE <http://webarchive.nationalarchives.gov.uk/+/http://www.dft.gov.uk/pgr/sustainable/travelplans/rpt/mrtpw.pdf>

³⁵ “The essential guide to Travel Planning”- DfT, 2008 <http://www.dft.gov.uk/pgr/sustainable/travelplans/work/essentialguide.pdf>

9. Car parking design guidance

The design of car parking provision is of considerable importance to ensure that car parking is attractive to use and also plays a constructive part in the design of developments. Poorly designed car parking may result in wasted land and inappropriate or unintended parking behaviour if, due to flaws in its design, it is not used. Similarly, parking provision which is not designed with care can inconvenience pedestrians and may be unsightly.

The quantity and basic dimensions of parking provided at developments should be in line with the requirements and recommendations in Sections 4, 5 and 6 of this document.

The design of parking should take into account recommendations in the following design guidance documents:

- For primarily residential streets, designs should follow principles set out in Manual for Streets and the Southampton City Council Residential Design Guide SPG chapter on access and parking;
- For mixed use streets (residential and other uses) and main corridors in urban areas, designs should follow principles set out in Manual for Streets and/ or Manual for Streets 2 and the Southampton City Council Development Design Guide SPG and Streetscape Manual SPG; and
- For roads outside of urban areas and in locations where the sole function of the highway is as a transport corridor, Design Manual for Roads and Bridges is the appropriate design guidance. In an urban area such as Southampton, there are very few locations to which this design standard would apply.

All developments must design their parking provision in line with the guidance in Chapter 5 (Parking and Access) of the [SCC Residential Design Guide SPG](#)³⁶.

Other relevant SCC guidance includes:

- [Streetscape Manual SPG](#)³⁷; and
- [Development Design Guide SPG](#)³⁸.

³⁶ <http://www.southampton.gov.uk/s-environment/policy/planningdocuments/residentialdesignguide.aspx>

³⁷ <http://www.southampton.gov.uk/s-environment/policy/planningdocuments/street-scape.aspx>

³⁸ <http://www.southampton.gov.uk/s-environment/policy/planningdocuments/dev-design.aspx>

10. Bibliography

Local Policy

[City of Southampton Strategy. Southampton City Council, 2006](#)³⁹

[Southampton Local Development Framework \(LDF\) Core Strategy. Southampton City Council, 2010](#)⁴⁰

[Southampton Local Transport Plan 3 \(LTP3\). Southampton City Council, 2011](#)⁴¹

National Policy

[Planning Policy Guidance 13 \(PPG13\): Transport. Department for Communities & Local Government, 2011](#)⁴²

[Planning Policy Statement 3 \(PPS3\): Housing. Department for Communities and Local Government, 2010](#)⁴³

[Planning Policy Statement 4 \(PPS4\): Planning for Sustainable Economic Growth. Department for Communities and Local Government, 2009](#)⁴⁴

Local Design Guidance

[SCC Development Design Guide SPG. Southampton City Council, 2004](#)⁴⁵

[SCC Residential Design Guide SPG - Section 5 Access and Parking. Southampton City Council, 2006](#)⁴⁶

[SCC Streetscape Manual SPG. Southampton City Council, 2005](#)⁴⁷

National Design Guidance

[Manual for Streets. Department for Transport, 2007](#)⁴⁸

[Manual for Streets 2: Wider Application of the Principles. Chartered Institute of Highways and Transportation, 2010](#)⁴⁹

[Design Manual for Roads and Bridges. Department for Transport, March 2011 amendment](#)⁵⁰

³⁹ <http://www.southampton.gov.uk/council-partners/decisionmaking/plans/CoSS.aspx>

⁴⁰ <http://www.southampton.gov.uk/s-environment/policy/developmentframework/core-strategy/stage5.aspx>

⁴¹ <http://www.southampton.gov.uk/s-environment/transportplanning/localtransportplan3/>

⁴² <http://www.communities.gov.uk/publications/planningandbuilding/ppg13>

⁴³ <http://www.communities.gov.uk/publications/planningandbuilding/pps3housing>

⁴⁴ <http://www.communities.gov.uk/publications/planningandbuilding/planningpolicystatement4>

⁴⁵ <http://www.southampton.gov.uk/s-environment/policy/planningdocuments/dev-design.aspx>

⁴⁶ http://www.southampton.gov.uk/Images/0D%2005%20Access%20and%20Parking_tcm46-178890.pdf

⁴⁷ <http://www.southampton.gov.uk/s-environment/policy/planningdocuments/street-scape.aspx>

⁴⁸ <http://www.dft.gov.uk/pgr/sustainable/manforstreets/pdfmanforstreets.pdf>

⁴⁹ <http://www.ciht.org.uk/en/publications/technical-guidelines.cfm/manual-for-streets-2--wider-application-of-the-principles-2010>

⁵⁰ <http://www.dft.gov.uk/ha/standards/dmrb/index.htm>

Research and Guidance on Car Parking Standards and Design

[The Manual for Streets: Evidence and Research. TRL, 2007⁵¹](#)

[Marsden G.R., 2006 The evidence base for parking policies- a review. Transport Policy, 13 \(6\). pp. 447-457⁵²](#)

[Residential Car Parking Research. Department for Communities and Local Government, 2007⁵³](#)

[Public experiences of and attitudes toward parking. Department for Transport, 2008⁵⁴](#)

[Guidance on the permeable surfacing of front gardens. Department for Communities and Local Government, 2009⁵⁵](#)

[New Homes 2010- Chapter 16: Parking. Secured by Design, 2010⁵⁶](#)

Research and Guidance on Cycle Parking Standards and Design

[Information Sheet FF37:Cycle Parking. CTC/ Sustrans, 2004⁵⁷](#)

[Traffic Advisory Leaflet 5/02: Key elements of cycle parking provision. Department for Transport, 2002⁵⁸](#)

[Cycle Parking Guide For New Residential Developments. Cambridge City Council, 2010.⁵⁹](#)

[New Homes 2010- Chapter 35: Cycle Parking. Secured by Design, 2010⁶⁰](#)

[Code for Sustainable Homes Technical Guide: Issue Ene8- Cycle Storage. Department for Communities and Local Government, 2010⁶¹](#)

[BREEAM Scheme Documents-Offices⁶²](#)

[Design Portfolio C.04-Cycle Parking. Cycling England, 2002⁶³](#)

⁵¹ <http://www.dft.gov.uk/pgr/sustainable/manforstreets/manualforstreetsevidence.pdf>

⁵² <http://eprints.whiterose.ac.uk/2023/>

⁵³ <http://www.communities.gov.uk/publications/planningandbuilding/residentialcarparking>

⁵⁴ <http://www.dft.gov.uk/pgr/statistics/datatablespublications/trsnstatsatt/parking>

⁵⁵ <http://www.communities.gov.uk/publications/planningandbuilding/pavingfrontgardens>

⁵⁶ http://www.securedbydesign.com/pdfs/SBD_New_Homes_2010.pdf

⁵⁷ <http://www.tfw.org.uk/documents/SustransCycleparkingsheetFF37.pdf>

⁵⁸ http://www.dft.gov.uk/adobepdf/165240/244921/244924/TAL_5-02.pdf

⁵⁹ http://www.cambridge.gov.uk/public/docs/CycleParkingGuide_std.pdf

⁶⁰ http://www.securedbydesign.com/pdfs/SBD_New_Homes_2010.pdf

⁶¹ <http://www.communities.gov.uk/publications/planningandbuilding/codeguide>

⁶² <http://www.breeam.org/page.jsp?id=301>

⁶³ http://www.dft.gov.uk/cyclingengland/site/wp-content/uploads/2011/01/c04_cycle_parking.pdf

Travel Planning

[The Essential Guide to Travel Planning. *Department for Transport, 2008*](#)⁶⁴

[Making Residential Travel Plans Work. *Department for Transport, 2005*](#)⁶⁵

Electric Vehicle Charge Point Design

[Guidance for Implementation of electric vehicle charging infrastructure. *Transport for London, 2010*](#)⁶⁶

⁶⁴ www.dft.gov.uk/pgr/sustainable/travelplans/work/essentialguide.pdf

⁶⁵

<http://webarchive.nationalarchives.gov.uk/+/http://www.dft.gov.uk/pgr/sustainable/travelplans/rpt/makingresidentialtravelplans57>

⁷⁵

⁶⁶ <http://www.newride.org.uk/downloads/EVCP-Guidance-Apr10.pdf>